

**Customized.
Fail-safe.
Long-lasting.**

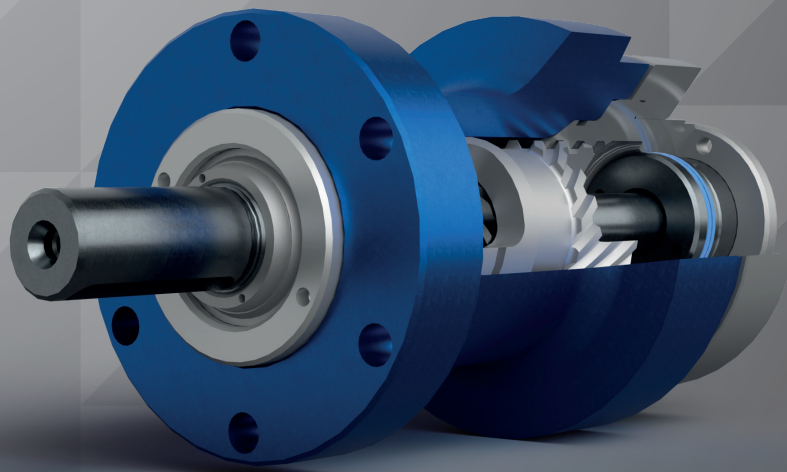

Hydraulic rotary actuators for industrial applications
I-DA-H



55 Years of
Experience

NEXT LEVEL

More features – more flexibility

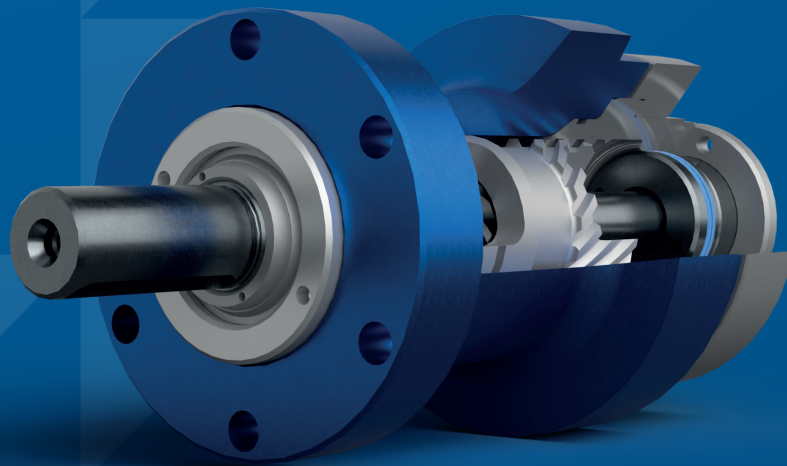

Why switch to the I-DA-H? Find out more at
www.hks-partner.com/next-level



I-DA-H

The new
standard

**Hydraulic rotary actuator for
industrial applications**

We are your partner for custom hydraulic
rotary actuators **when downtime is not an
option.**

Today, we design precision-fit motion solutions for
demanding applications so that **you remain competitive
tomorrow as well.**

All in – standard benefits

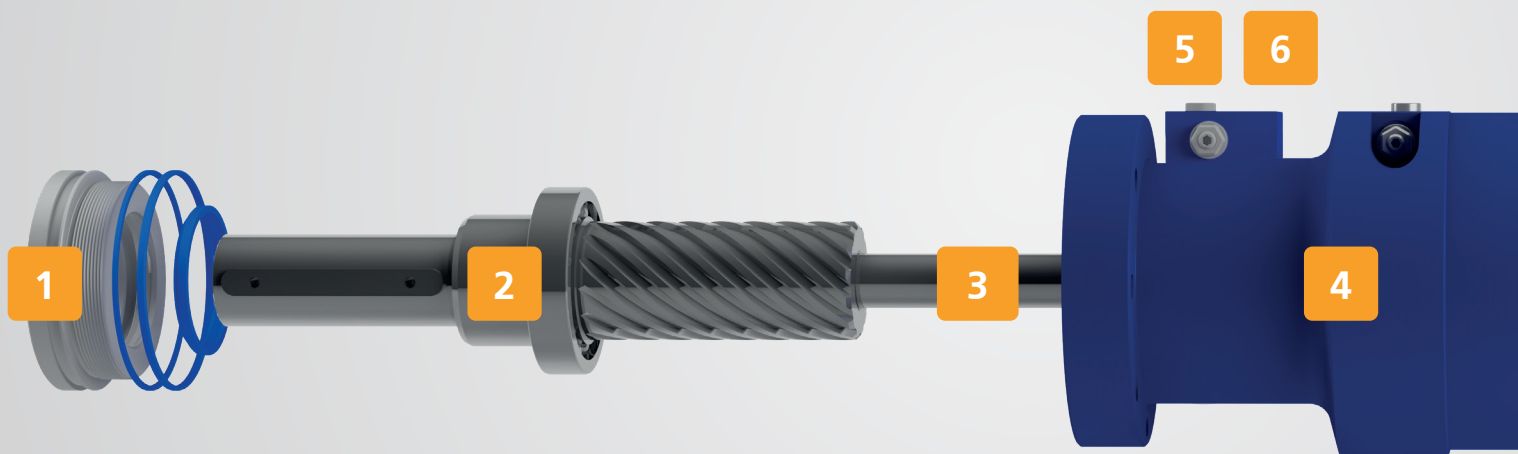

Interleaved gears are surface-hardened

- › Nearly maintenance-free
- › Increases effectiveness

Rotary pistons can be run to their end stop positions and loaded

- › No external end stops required

Rotation angle or end stop query possible via camshaft

- › Precise positioning of rotation angle
- › Standard rotation angles 90°, 180°, 270° and 360°

Greater working pressure

- › Up to 20% more power

Improved bearing efficiency with four-point bearing

- › For handling strong radial and axial forces
- › For greater longevity

Any intermediate rotation angle possible

- › Customer-specific adaptation and integration into existing systems

Improved end position cushioning

- › Soft braking of mass moments of inertia
- › Results in greater longevity for the entire system

- | | | |
|-----------------------------|---------------------------|---|
| 1 Sealing ring | 5 Cushioning | 9 Annular gear |
| 2 Shaft with bearing | 6 Bleed screws | 10 Base |
| 3 Camshaft | 7 Piston | 11 Load holding valve
(optional, not shown) |
| 4 Housing | 8 Regulating screw | |

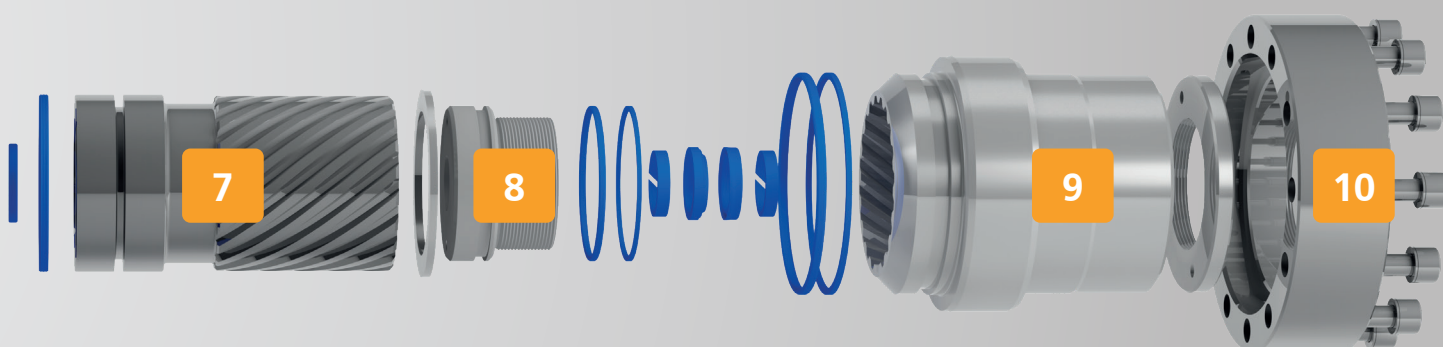

Angular adjustments

- > Precise travel to rear end position
- > $\pm 4^\circ$ angular adjustment

State-of-the-art sealing technology

- > Ensures less wear
- > Longer service life for the entire system
- > No internal leakage
- > Increases safety

Infinite adjustment of the shaft position

- > Shaft position can be adjusted at any time
- > Overall angle can be shifted

Notes for application planning



Whatever you are planning, the rotary actuator can be optimally adapted. Many installation and connection options are available as standard, and custom special solutions can also be implemented.

Our technical customer advisors will be pleased to support you with your inquiries regarding special solutions through comprehensive, holistic solution concepts.

Kai Frischkorn
 T: +49 6053 6163-0
 E: k.frischkorn@hks-partner.com

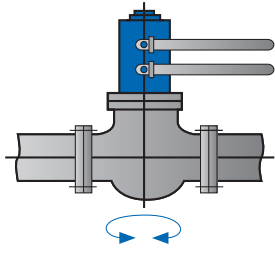

Ballcocks, armatures

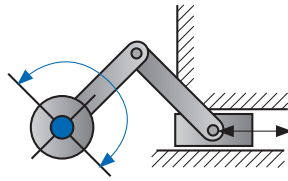

Crank drive

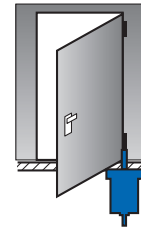

Doors, gates

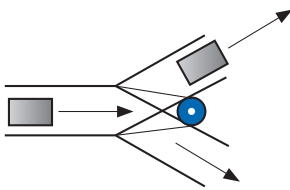

Transportation systems

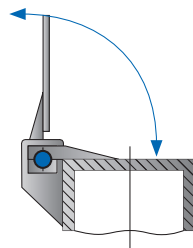

Cover activation

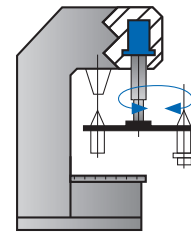

Tool changers

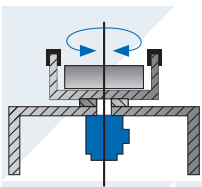

Tilting table

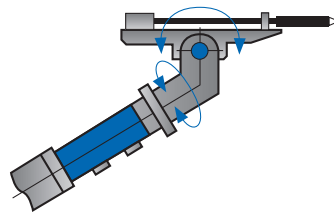

Drills

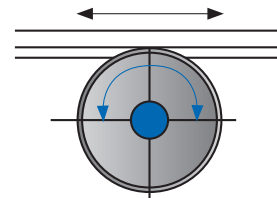

Linear transport

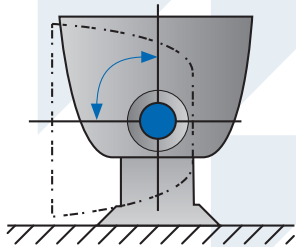

Container-tilting appliances

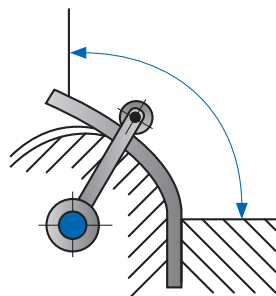

Pipe and sheet metal bending machines

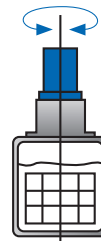

Mixers

Dynamic solutions

Optimal Customer Solutions

To capture all ideas and transform them into an optimal design for your specific requirements, we employ an experienced team of designers, technicians, and development engineers. This team works closely with you as the customer. The result of this collaboration is a finished HKS rotary actuator with precisely the applications you need.

We are always happy to take on your challenges with passion and commitment. Equipped with the latest hardware and software, our designers develop efficient HKS products for you. Partnership, professional exchange, and teamwork are key elements in this process. Only in close cooperation with you as the customer—and of course with our technically experienced customer advisors—do outstanding HKS products come to life.

What distinguishes a product from HKS Dreh-Antriebe GmbH:

- › Ingenuity that reflects the diversity of applications
- › A clear design language and compact design
- › Functionality that is perfectly tailored to engineers' requirements
- › The highest quality of materials and workmanship
- › An attractive price-performance ratio
- › Service that ensures long-term reparability of the products, should it be required

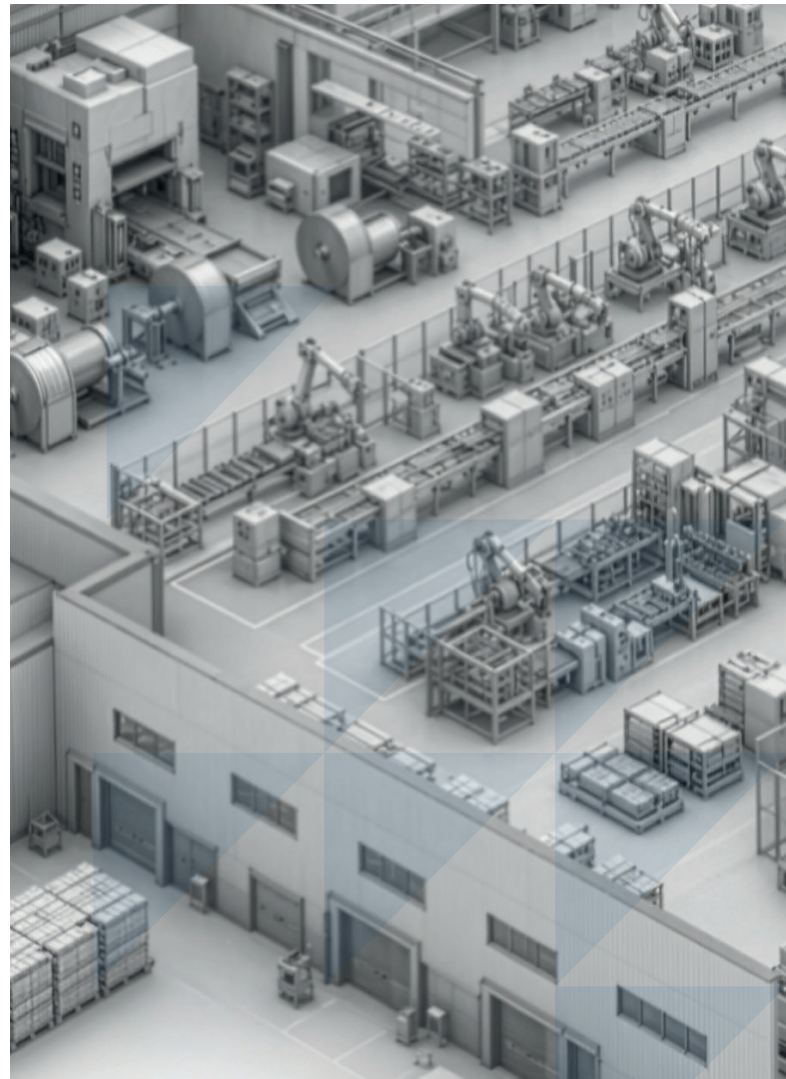

Further options – exactly as requested

- › Drive shaft with various spline shaft profiles
- › Drive shaft with second drive cog
- › Drive shaft and mounting flange can be designed to customer specifications
- › Angular adjustment across the entire rotation area
- › Limit switch facility
- › Rotation angle query
- › Any intermediate rotation angle can be supplied
- › Rotation range over 360°
- › Resistant to freshwater and seawater
- › Outboard bearing for high radial forces
- › Direction of rotation changeable
- › Compressed air version
- › Aluminum housing
- › According to ATEX product guidelines
- › Optional connections for servo interfaces
- › Optional version for use with organic lubricants or other pressurized fluids
- › Other special-purpose designs available

We build the best rotary actuators for your needs!

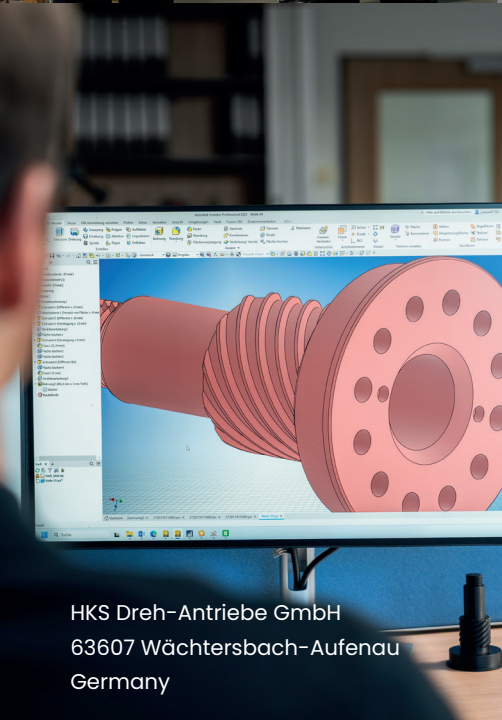

www.hks-partner.com

HKS Dreh-Antriebe GmbH
63607 Wächtersbach-Aufenuau
Germany